

### Features

- 45 - 1000MHz
- 22.5dB Gain at 45MHz
- CSO 61dBc @+15dBmV
- CTB 75dBc @+15dBmV
- NF 2.0dB
- Lead-free / Green / RoHS-compliant SOT-89 Package



### Applications

- Headend Driver Amplifier
- Predriver Amplifier
- Line Driver Amplifier
- Optic Transceiver Application
- MOCA
- FTTH Application

### Functional Diagram

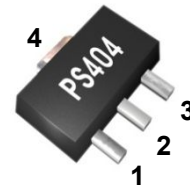

Function	Pin No.
RF IN	1
RF OUT / Bias	3
Ground	2,4

### Description

The PS404 is a high performance InGaP HBT MMIC Amplifier and consists of Darlington pair amplifiers that is internally matched to 75Ω input/output. The amplifier features high gain, high linear performance, wideband operation, high reliability, low noise as an CATV amplifier. The PS404 operates from a single voltage supply and requires only two DC-blocking capacitors, a bias resistor and an inductor for operation. The device is a general purpose CATV amplifier that offers high dynamic range in a low cost surface-mountable plastic SOT-89 packages. All devices are 100% RF and DC tested.

### Specifications

\* Test Conditions : T=25°C, Supply Voltage=+5V, 75ohm System

Symbol	Parameters	Units	Min.	Typ.	Max.	Condition
<b>Forward ( 45MHz ~ 1000MHz )</b>						
S21	Gain	dB	21.5	22.5	23.5	45 ~ 1000MHz
S11	Input Return Loss	dB	-11	-13		45 ~ 1000MHz
S22	Output Return Loss	dB	-7	-9		45 ~ 1000MHz
CSO	Composite Second Order	dBc		61		+15dBmV/132ch Flat
CTB	Composite Triple Beat	dBc		75		+15dBmV/132ch Flat
OIP3	Output Third Order Intercept Point	dBm		31.0		Note 1
P1dB	Output Power at 1dB Compression	dBm		15.5		
NF	Noise Figure	dB		2.0		
I	Current	mA	45	55	65	
<b>Reverse ( 5MHz ~ 100MHz )</b>						
S21	Gain	dB	22.5	23.5	24.5	5 ~ 100MHz
S11&S22	Return Loss	dB	-9	-11		5 ~ 100MHz
OIP3	Output Third Order Intercept Point	dBm		32.5		Note 1
P1dB	Output Power at 1dB Compression	dBm		15.2		
NF	Noise Figure	dB		1.9		
I	Current	mA	35	45	55	
Rth	Thermal Resistance	°C/W		75		

Note 1. Two Tones, 1MHz Spacing, +5dBm per Tone at Output

### 45 - 1000MHz CATV Application Circuit

### Recommended Bias Values

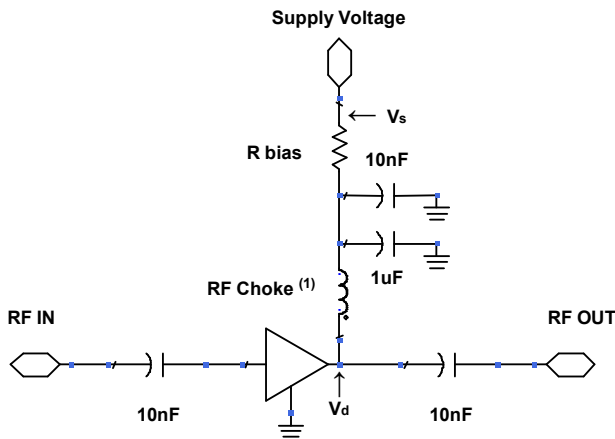

Supply Voltage	R bias Value	Size
5 V	22.0 Ω	1210
6 V	39.0 Ω	1210
8 V	75.0 Ω	2010
10 V	110.0 Ω	2010
12 V	150.0 Ω	2512

$R_{bias} = (V_s - V_d) / I_d$

1. RF Choke is about 4uH. We recommend that wire of 0.2 phi radius wind 4 turns on toroidal core(size:4.0x1.5x2.0)
2. Measurement for our datasheet was made on 1.6mm thick FR-4 Board. And 75 ohm microstrip line

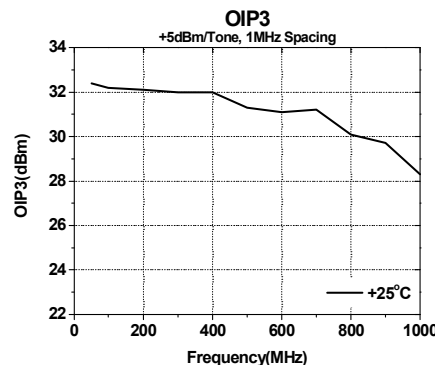
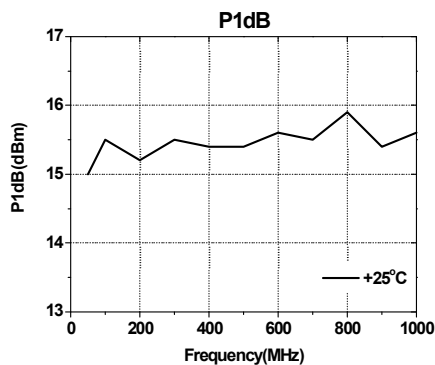
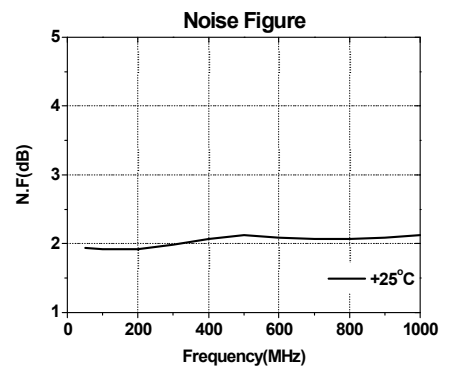
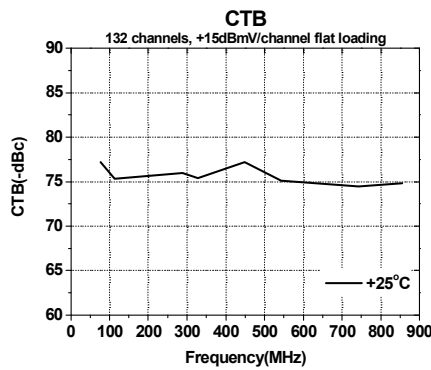
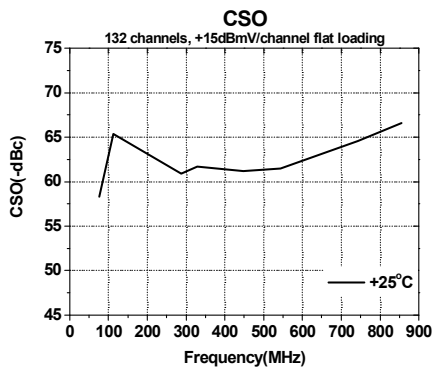
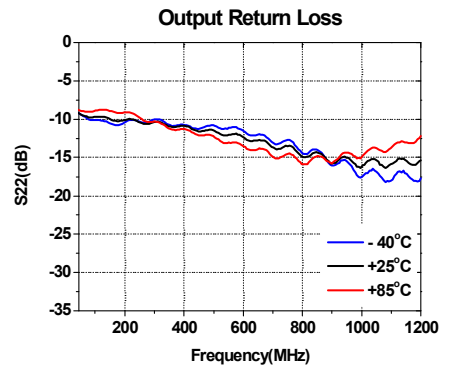
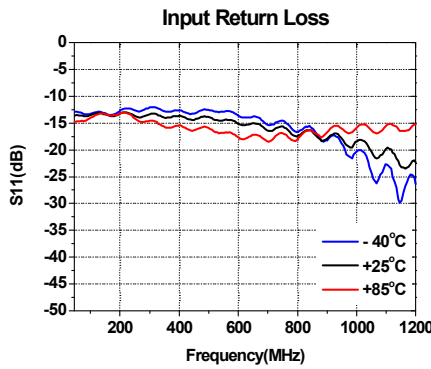
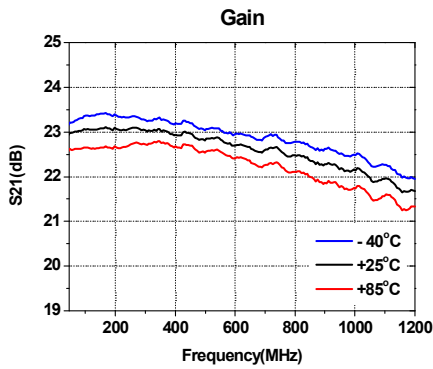

### 5 -100MHz CATV Application Circuit

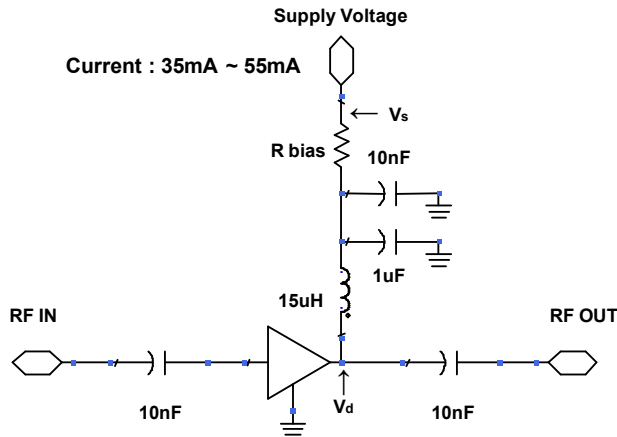

### Recommended Bias Values

Supply Voltage	R bias Value	Size
5 V	22.0 Ω	1210
6 V	39.0 Ω	1210
8 V	75.0 Ω	2010
10 V	110.0 Ω	2010
12 V	150.0 Ω	2512

$R_{bias} = (V_s - V_d) / I_d$

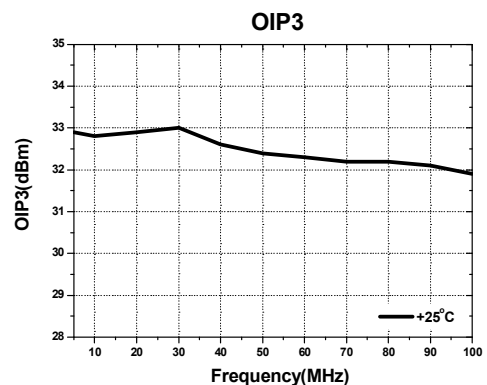
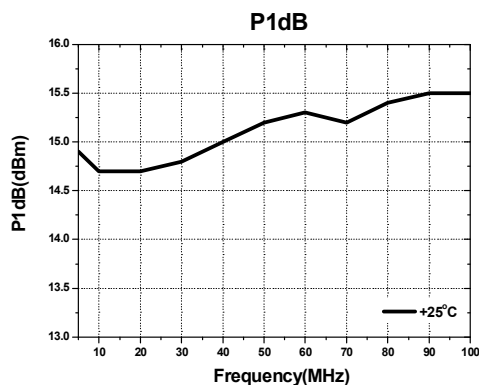
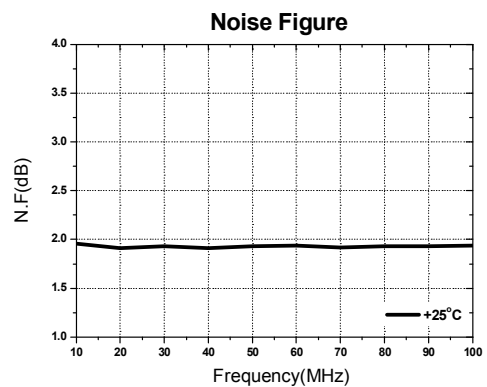
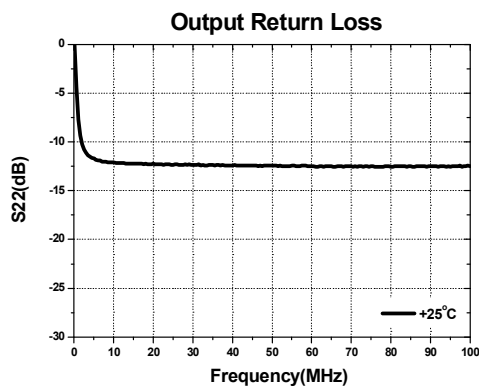
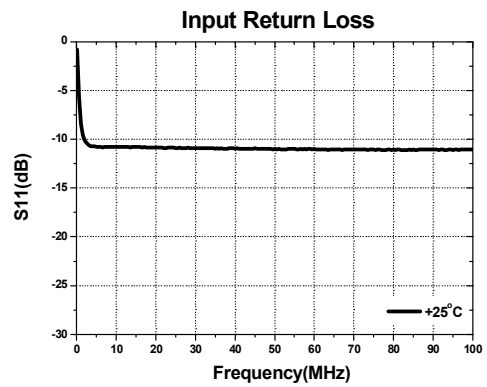
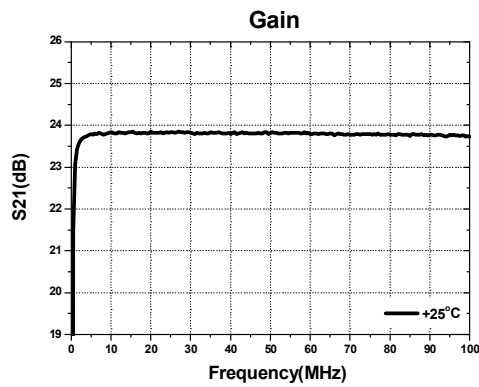

### Absolute Maximum Ratings

Parameter	Rating	Unit
Device Voltage	+3.8	V
Device Current	150	mA
RF Power Input	8	dBm
Storage Temperature	-55 to +125	°C
Ambient Operating Temperature	-40 to +85	°C
Junction Temperature	160	°C

Operation of this device above any of these parameters may cause permanent damage.



### Lead-free / RoHS Compliant / Green SOT-89 Package Outline

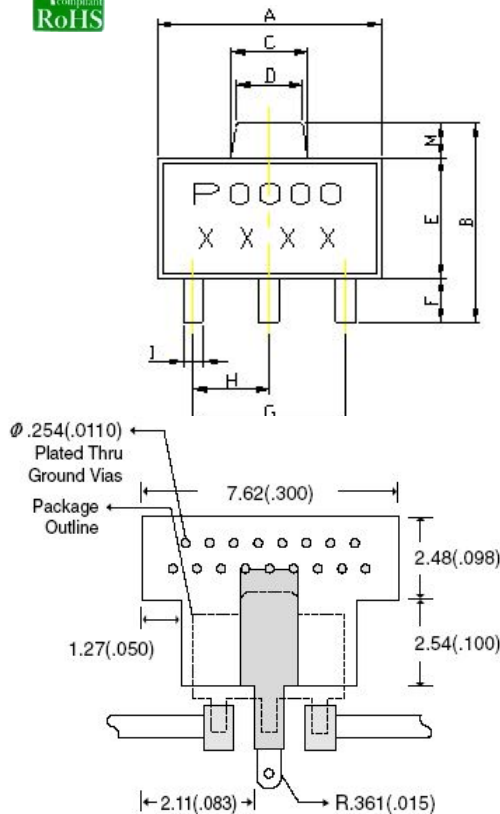

REF	DIMENSIONS	
	Millimeters	
	Min.	Max.
A	4.40	4.60
B	4.05	4.25
C	1.50	1.70
D	1.30	1.50
E	2.40	2.60
F	0.89	1.20
G	3.00 REF.	
H	1.50 REF.	
I	0.40	0.52
J	1.40	1.60
K	0.35	0.41
L	5° TYP.	
M	0.70 REF.	

### ESD / MSL Ratings

- ESD sensitive device. Observe Handling Precautions.
- ESD Rating : Class 2(Passes at 2000V min.) Human Body Model (HBM), JESD22-A114
- ESD Rating : Class IV (Passes at 1000V min.) Charged Device Model (CDM), JESD22-C101
- MSL (Moisture Sensitive Level) Rating : Level 3 at +260°C Convection reflow, J-STD-020

### Evaluation Board Layout (30x40)

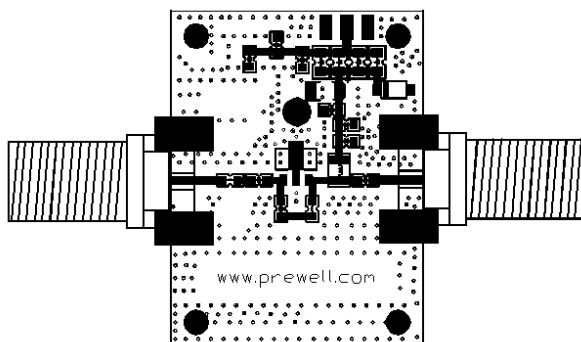

### Mounting Instructions

- Use a large ground pad area with many plated through-holes as shown.
- We recommend 1 oz copper minimum.
- Measurement for our data sheet was made on 1.6mm thick FR-4 Board.
- Add as much copper as possible to inner and outer layers near the part to ensure optimal thermal performance.
- RF trace width depends on the board material and construction.
- Add mounting screws near the part to fasten the board to a heatsink.

<http://www.prewell.com>